

ROECO

Bearing Data

Ball Bearing Units

Bearing No. : **UCF211C**

Dimensions

L = 162

J = 130

N = 19

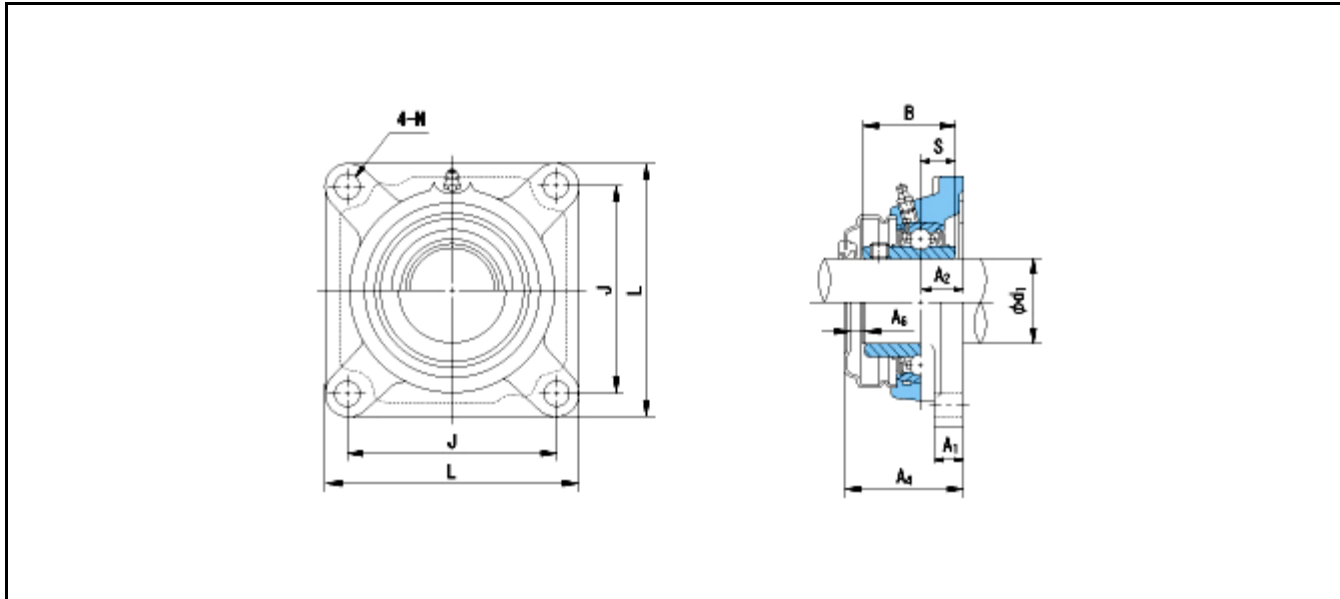

Dimensions

d1 = 55

A1 = 20

A2 = 25

B = 55.6

S = 22.2

A4 = 69

A6 = 9

Mass = 3.6 kg

Basic Dynamic Load Rating Cr :	43000 N		
Basic Static Load Rating Cor :	29400 N	O.D.Surface Runout with Side :	-
Limiting Speed ;		Axial Runout with Bore :	-
Grease Lubrication :	- rpm	Axial Runout with Raceway :	-
Oil Lubrication :	- rpm	Width Variation :	-
		Radial Runout :	-