

ROECO

Bearing Data

Ball Bearing Units

Bearing No. : **UCF205C**

Dimensions

L = 95

J = 70

N = 12

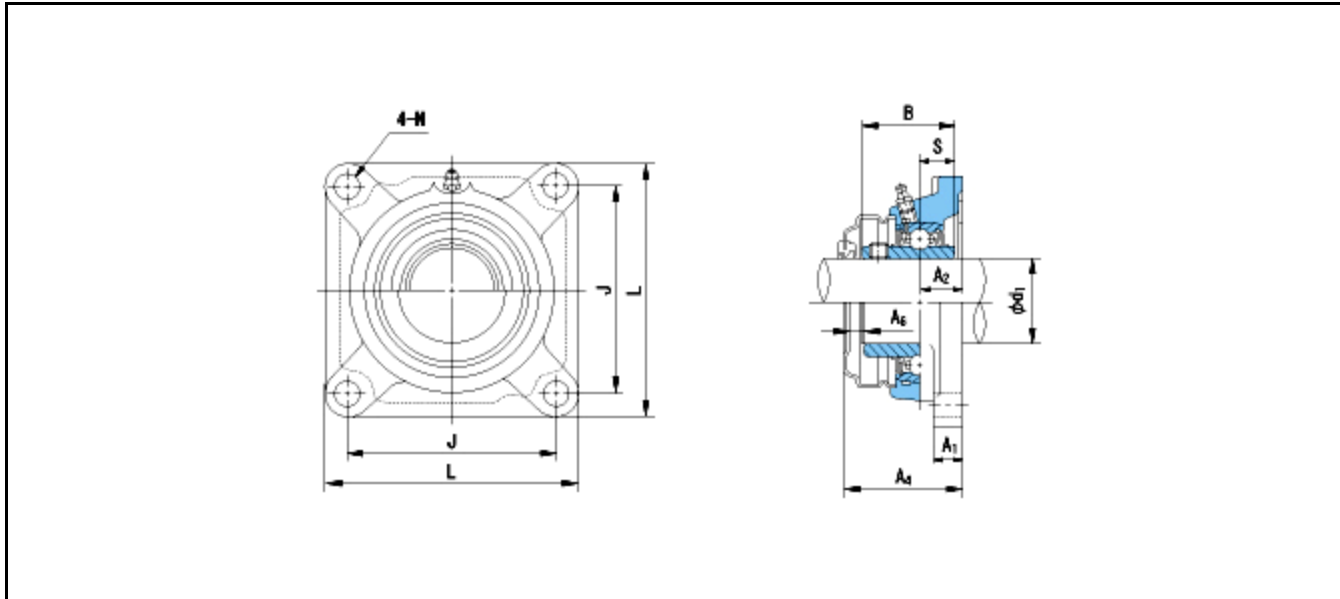

Dimensions

d1 = 25

A1 = 14

A2 = 16

B = 34

S = 14.3

A4 = 48

A6 = 11

Mass = 0.86 kg

Basic Dynamic Load Rating Cr :	14000 N			
Basic Static Load Rating Cor :	7900 N	O.D.Surface Runout with Side :		-
Limiting Speed ;		Axial Runout with Bore :		-
Grease Lubrication :	- rpm	Axial Runout with Raceway :		-
Oil Lubrication :	- rpm	Width Variation :		-
		Radial Runout :		-