

ROECO

Bearing Data

Ball Bearing Units

Bearing No. : **UCF204C**

Dimensions

L = 86

J = 64

N = 12

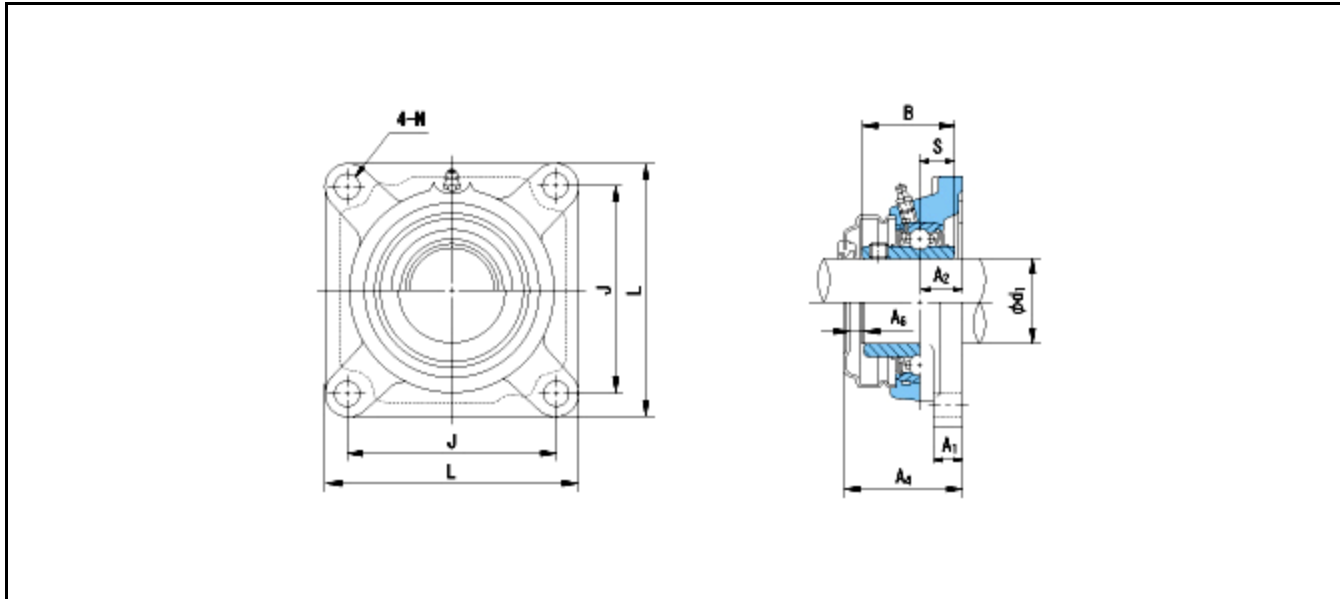

Dimensions

d1 = 20

A1 = 12

A2 = 15

B = 31

S = 12.7

A4 = 43

A6 = 8

Mass = 0.62 kg

Basic Dynamic Load Rating Cr :	12800 N		
Basic Static Load Rating Cor :	6600 N	O.D.Surface Runout with Side :	-
Limiting Speed ;		Axial Runout with Bore :	-
Grease Lubrication :	- rpm	Axial Runout with Raceway :	-
Oil Lubrication :	- rpm	Width Variation :	-
		Radial Runout :	-