

ROECO

Bearing Data

Ball Bearing Units

Bearing No. : **UCF203E**

Dimensions

L = 86

J = 64

N = 12

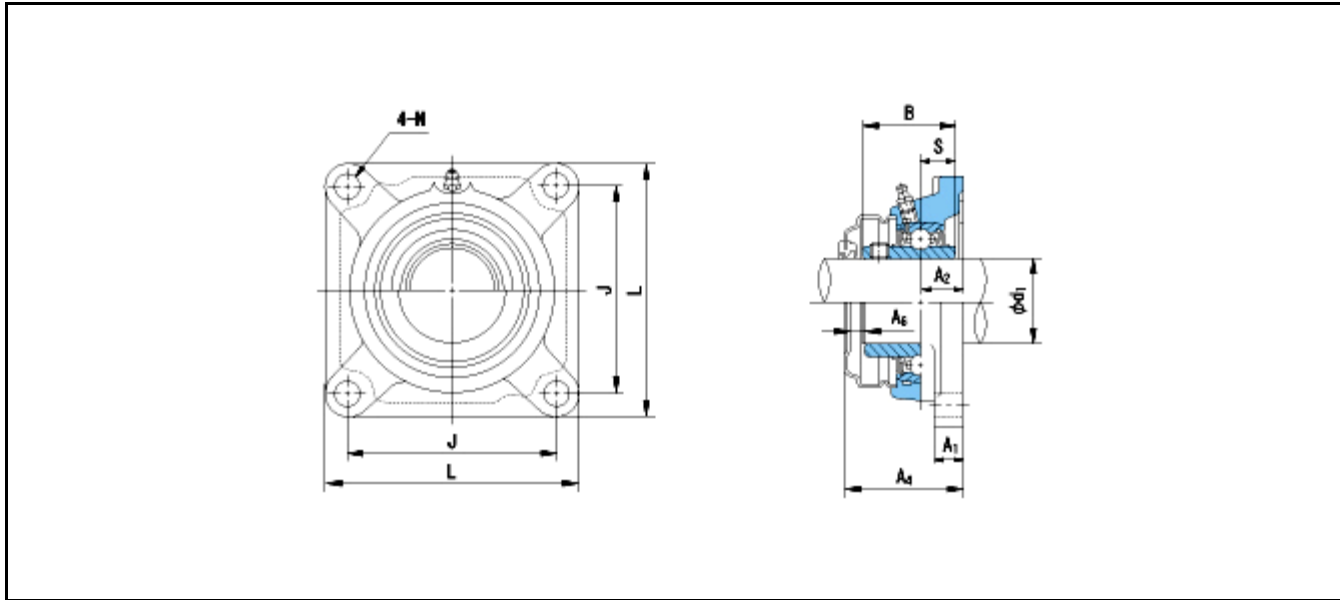

Dimensions

d1 = 17

A1 = 12

A2 = 15

B = 31

S = 12.7

A4 = 43

A6 = 8

Mass = 0.64 kg

Basic Dynamic Load Rating Cr :	12800 N				
Basic Static Load Rating Cor :	6600 N	O.D.Surface Runout with Side :			-
Limiting Speed ;		Axial Runout with Bore :			-
Grease Lubrication :	- rpm	Axial Runout with Raceway :			-
Oil Lubrication :	- rpm	Width Variation :			-
		Radial Runout :			-