

ROECO

# Bearing Data

## Ball Bearing Units

Bearing No. : **UCECH203**

Dimensions

Bi = 31

n = 12.7

c = 0

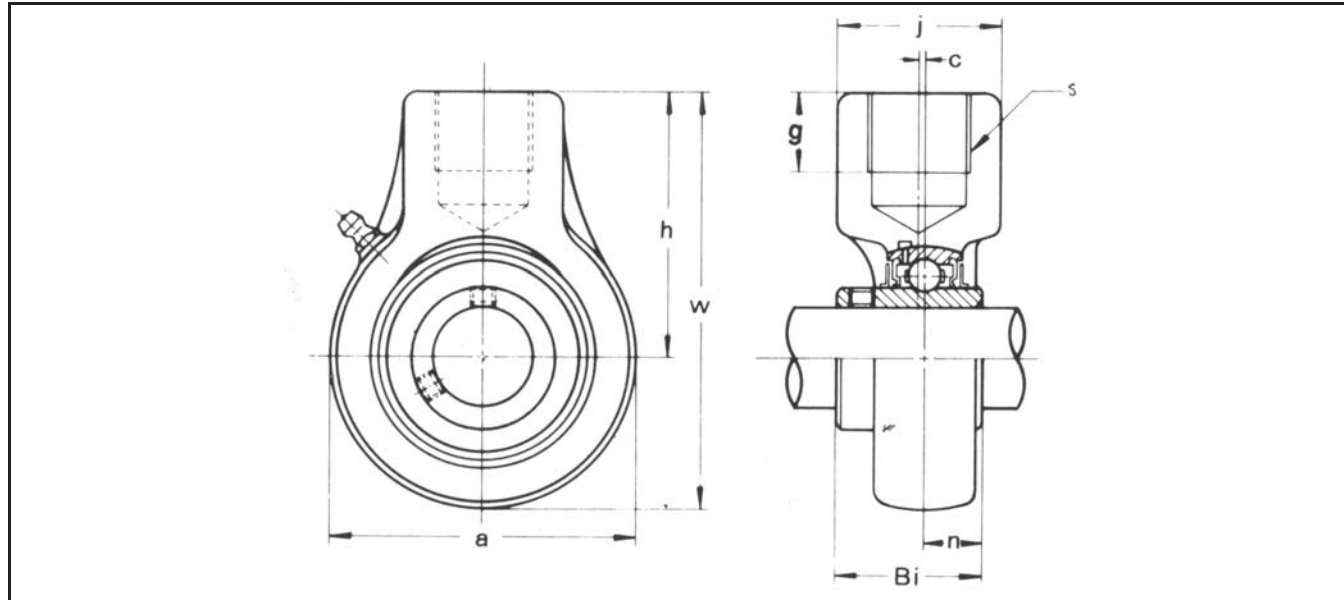

Dimensions

d1 = 17

a = 64

w = 96

h = 64

j = 40

s = PF 3/4

g = 19

Mass = 0804 kg

Basic Dynamic Load Rating Cr :	<b>13000N</b>		
Basic Static Load Rating Cor :	<b>6350 N</b>	O.D.Surface Runout with Side :	-
Limiting Speed ;		Axial Runout with Bore :	-
Grease Lubrication :	- rpm	Axial Runout with Raceway :	-
Oil Lubrication :	- rpm	Width Variation :	-
		Radial Runout :	-