

ROECO

Bearing Data

Ball Bearing Units

Bearing No. : **UCCX11**

Dimensions

H = 150

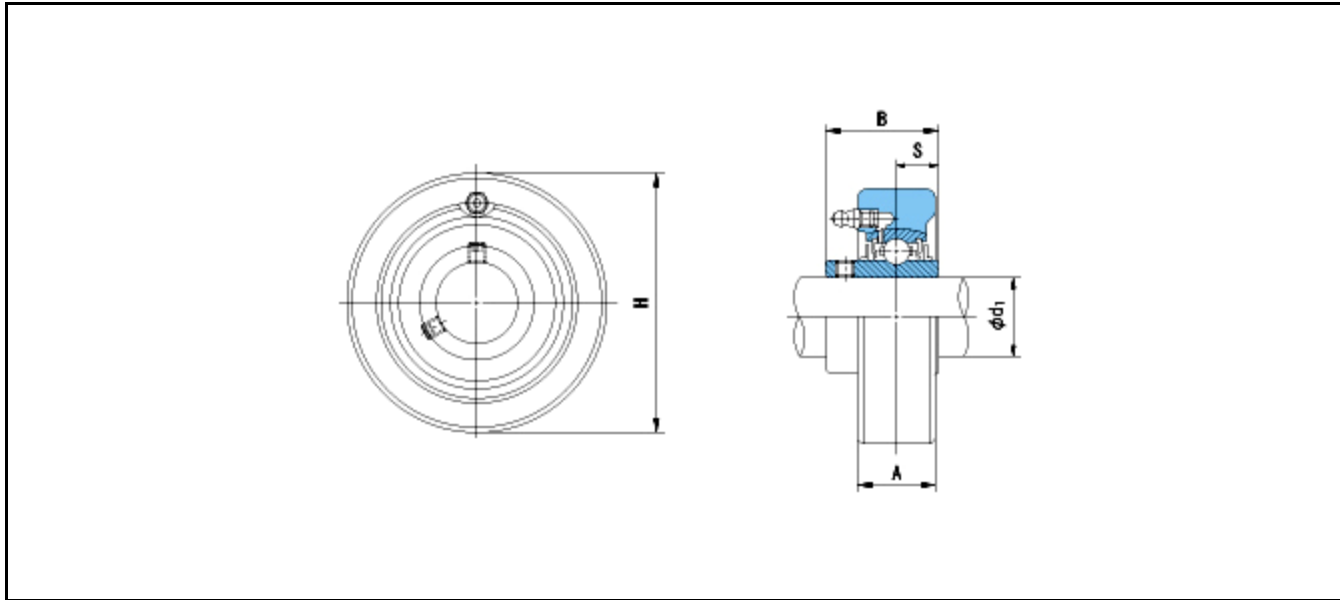

Dimensions

d1 = 55

A = 42

B = 65.1

S = 25.4

Mass = 4.7 kg

Basic Dynamic Load Rating Cr :	52500 N				
Basic Static Load Rating Cor :	36100 N	O.D.Surface Runout with Side :			-
Limiting Speed ;		Axial Runout with Bore :			-
Grease Lubrication :	- rpm	Axial Runout with Raceway :			-
Oil Lubrication :	- rpm	Width Variation :			-
		Radial Runout :			-