

ROECO

Bearing Data

Ball Bearing Units

Bearing No. : **UCC321**

Dimensions

H = 260

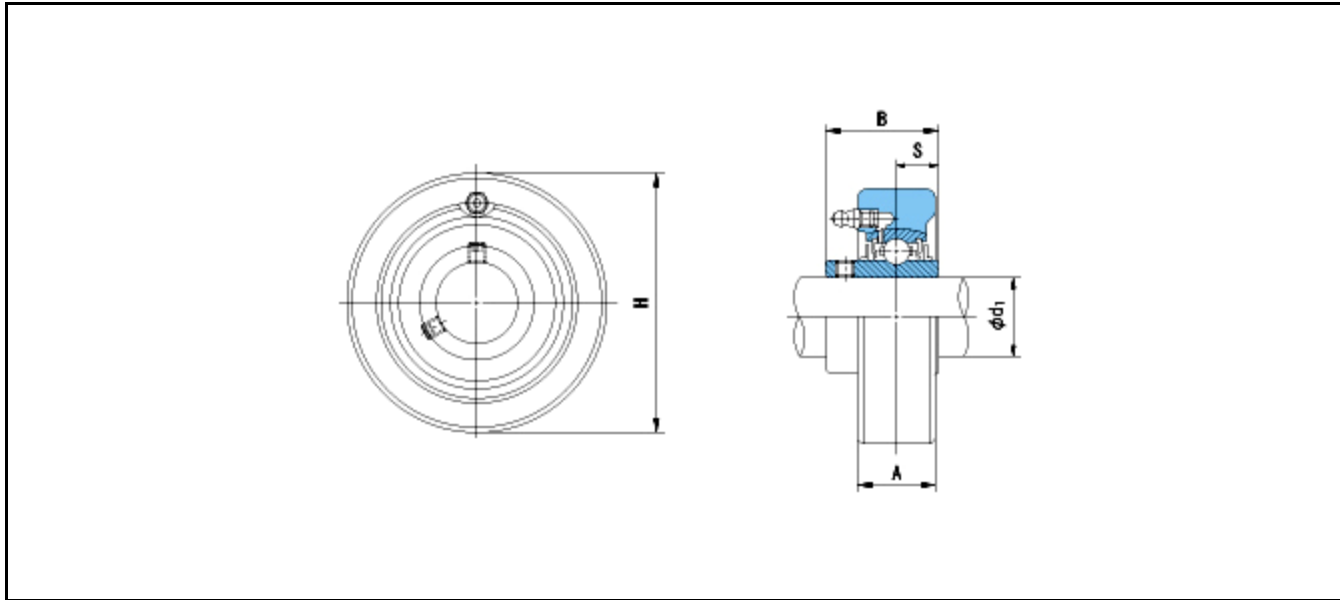

Dimensions

d1 = 105

A = 75

B = 112

S = 44

Mass = 18.9 kg

Basic Dynamic Load Rating Cr :	183000 N			
Basic Static Load Rating Cor :	153100 N	O.D.Surface Runout with Side :		-
Limiting Speed ;		Axial Runout with Bore :	-	
Grease Lubrication :	- rpm	Axial Runout with Raceway :	-	-
Oil Lubrication :	- rpm	Width Variation :	-	-
		Radial Runout :	-	-