

ROECO

Bearing Data

Ball Bearing Units

Bearing No. : **UCC317**

Dimensions

H = 215

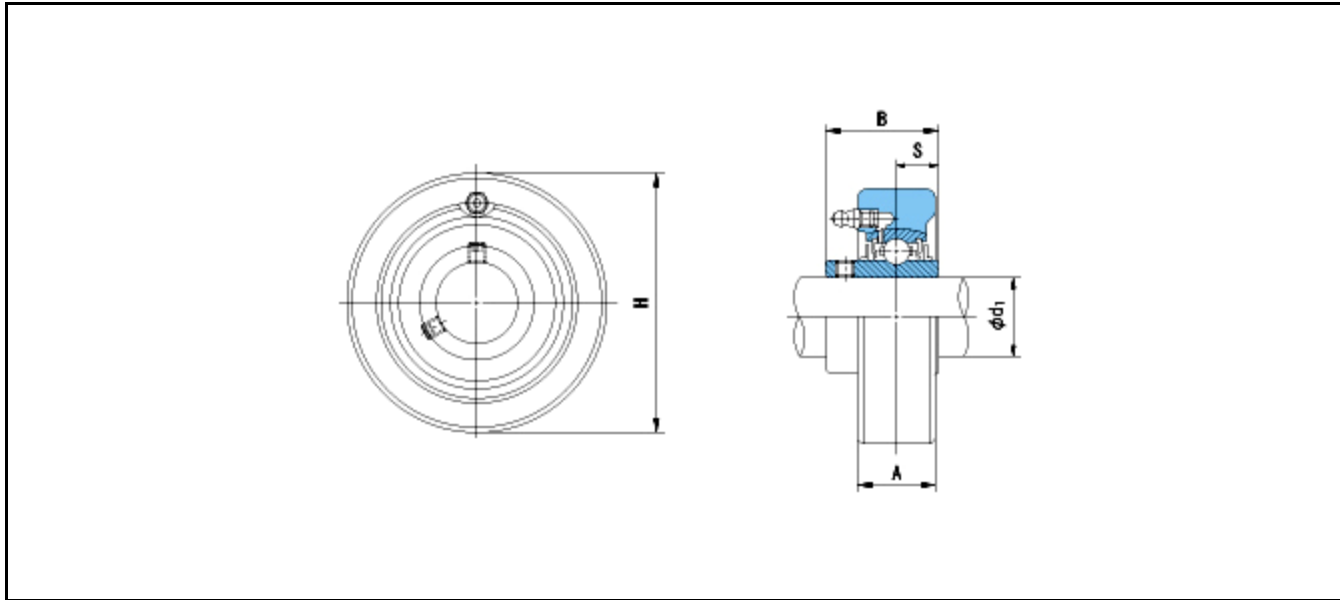

Dimensions

d1 = 85

A = 64

B = 96

S = 40

Mass = 11.2 kg

Basic Dynamic Load Rating Cr :	132000 N			
Basic Static Load Rating Cor :	96500 N	O.D.Surface Runout with Side :		-
Limiting Speed ;		Axial Runout with Bore :	-	
Grease Lubrication :	- rpm	Axial Runout with Raceway :	-	-
Oil Lubrication :	- rpm	Width Variation :	-	-
		Radial Runout :	-	-