

ROECO

Bearing Data

Ball Bearing Units

Bearing No. : **UCC316**

Dimensions

H = 200

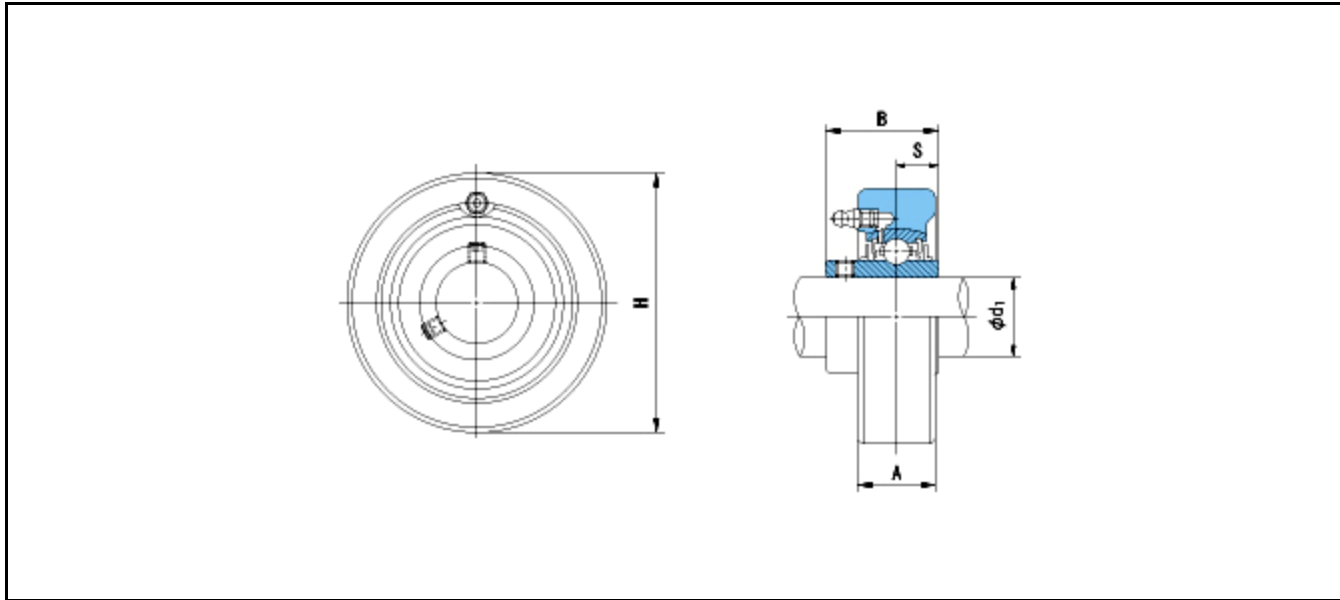

Dimensions

d1 = 80
A = 60
B = 86
S = 34
Mass = 8.9 kg

Basic Dynamic Load Rating Cr :	123000 N			
Basic Static Load Rating Cor :	86400 N	O.D.Surface Runout with Side :		-
Limiting Speed ;		Axial Runout with Bore :	-	
Grease Lubrication :	- rpm	Axial Runout with Raceway :	-	-
Oil Lubrication :	- rpm	Width Variation :	-	-
		Radial Runout :	-	-