

ROECO

Bearing Data

Ball Bearing Units

Bearing No. : **UCC315**

Dimensions

H = 190

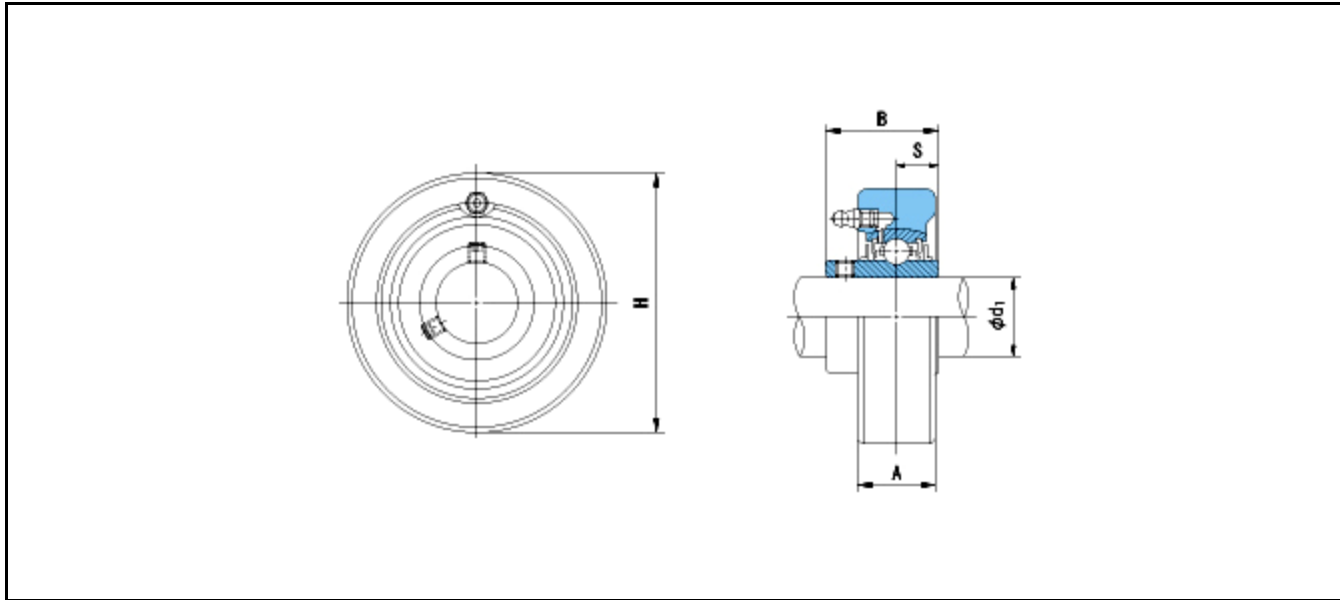

Dimensions

d1 = 75

A = 55

B = 82

S = 32

Mass = 7.7 kg

Basic Dynamic Load Rating Cr :	114000 N			
Basic Static Load Rating Cor :	76900 N	O.D.Surface Runout with Side :		-
Limiting Speed ;		Axial Runout with Bore :	-	
Grease Lubrication :	- rpm	Axial Runout with Raceway :	-	-
Oil Lubrication :	- rpm	Width Variation :	-	-
		Radial Runout :	-	-