

ROECO

Bearing Data

Ball Bearing Units

Bearing No. : **UCC212**

Dimensions

H = 130

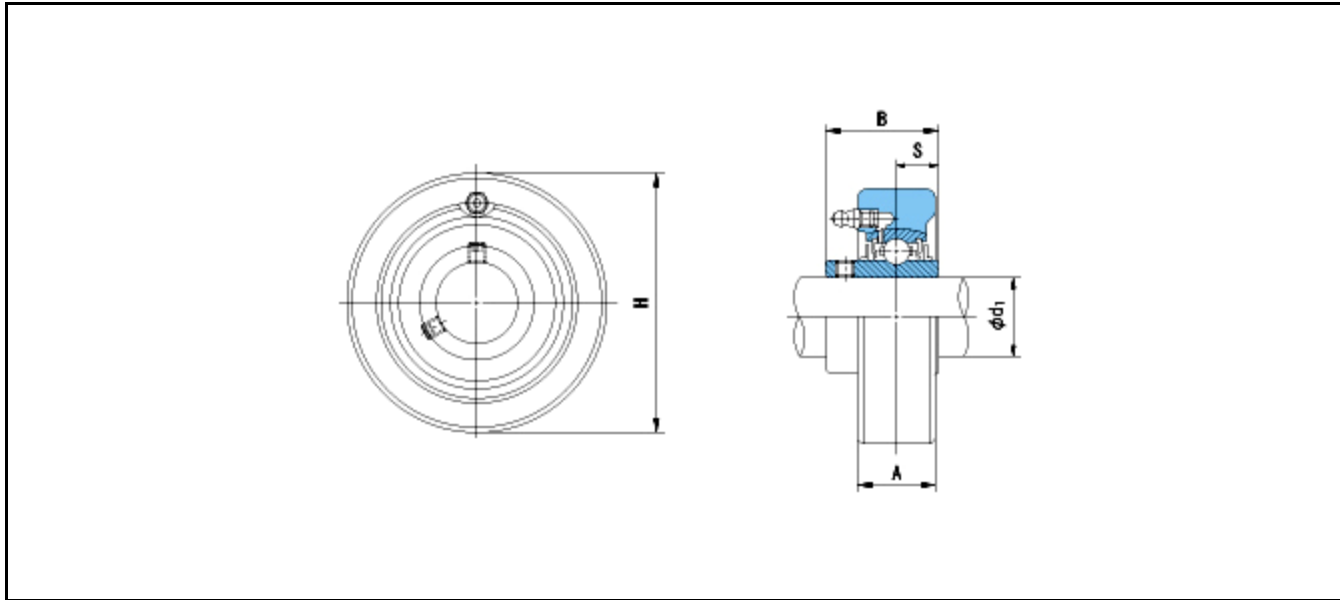

Dimensions

d1 = 60

A = 38

B = 65.1

S = 25.4

Mass = 2.5 kg

Basic Dynamic Load Rating Cr :	52500 N			
Basic Static Load Rating Cor :	36100 N	O.D.Surface Runout with Side :		-
Limiting Speed ;		Axial Runout with Bore :	-	
Grease Lubrication :	- rpm	Axial Runout with Raceway :	-	-
Oil Lubrication :	- rpm	Width Variation :	-	-
		Radial Runout :	-	-