

ROECO

Bearing Data

Ball Bearing Units

Bearing No. : **MUCPA202**

Dimensions

H = 30.2
L = 76
J = 52
G1 = M10*1.5
H1 = 5,7
H2 = 60,9

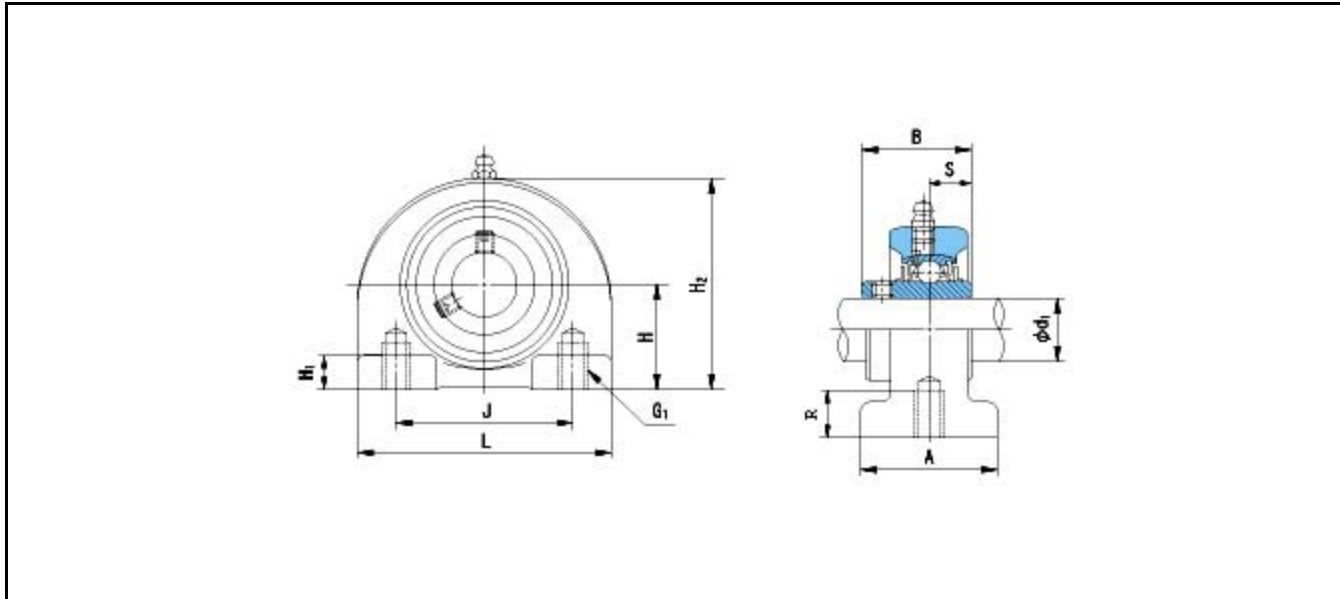

Dimensions

d1 = 15
A = 25,5
B = 31
S = 12.7

Mass = 0.47 kg

Basic Dynamic Load Rating Cr :	12800 N			
Basic Static Load Rating Cor :	6600 N	O.D.Surface Runout with Side :		-
Limiting Speed ;		Axial Runout with Bore :		-
Grease Lubrication :	- rpm	Axial Runout with Raceway :		-
Oil Lubrication :	- rpm	Width Variation :		-
		Radial Runout :		-