

ROECO

Bearing Data

Ball Bearing Units

Bearing No. : **MUCFL209**

Dimensions

H = 188

L = 108

J = 148

N = 19

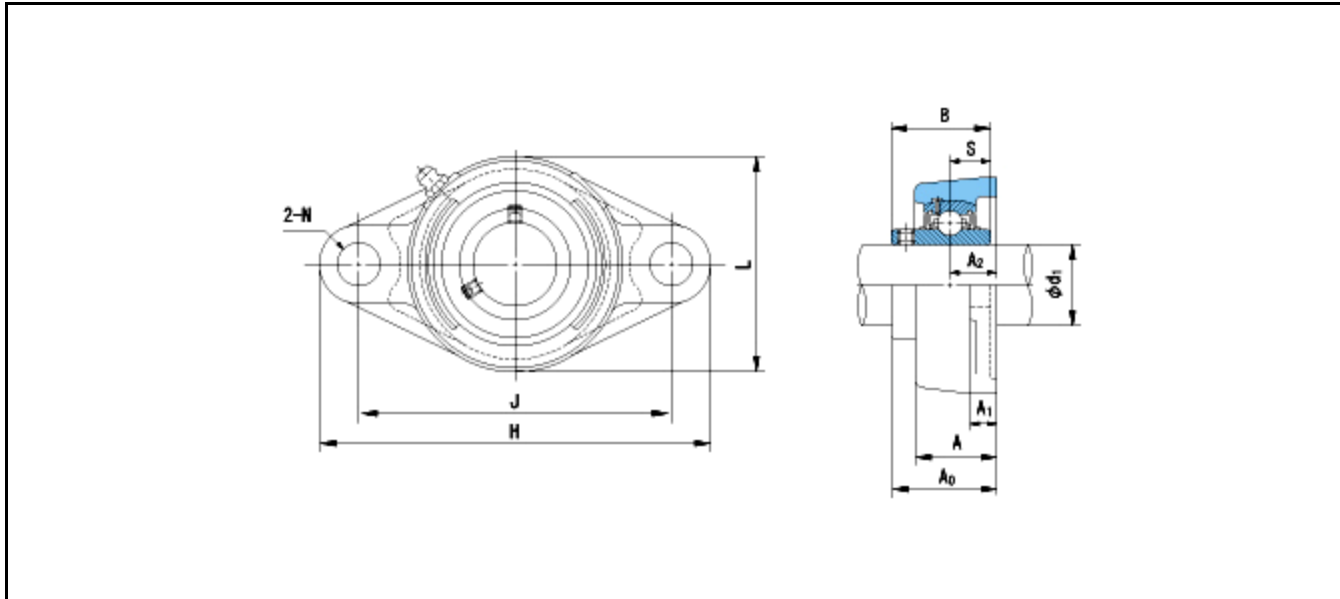

Dimensions

d1 = 45

A1 = 13

A2 = 22

A = 38

A0 = 52.2

B = 49.2

S = 19

Mass = 1.65 kg

Basic Dynamic Load Rating Cr :	28100 N			
Basic Static Load Rating Cor :	16400 N	O.D.Surface Runout with Side :		-
Limiting Speed ;		Axial Runout with Bore :		-
Grease Lubrication :	- rpm	Axial Runout with Raceway :		-
Oil Lubrication :	- rpm	Width Variation :		-
		Radial Runout :		-