

ROECO

Bearing Data

Ball Bearing Units

Bearing No. : **KHPF203**

Dimensions

L = 81

J = 63.5

N = 7

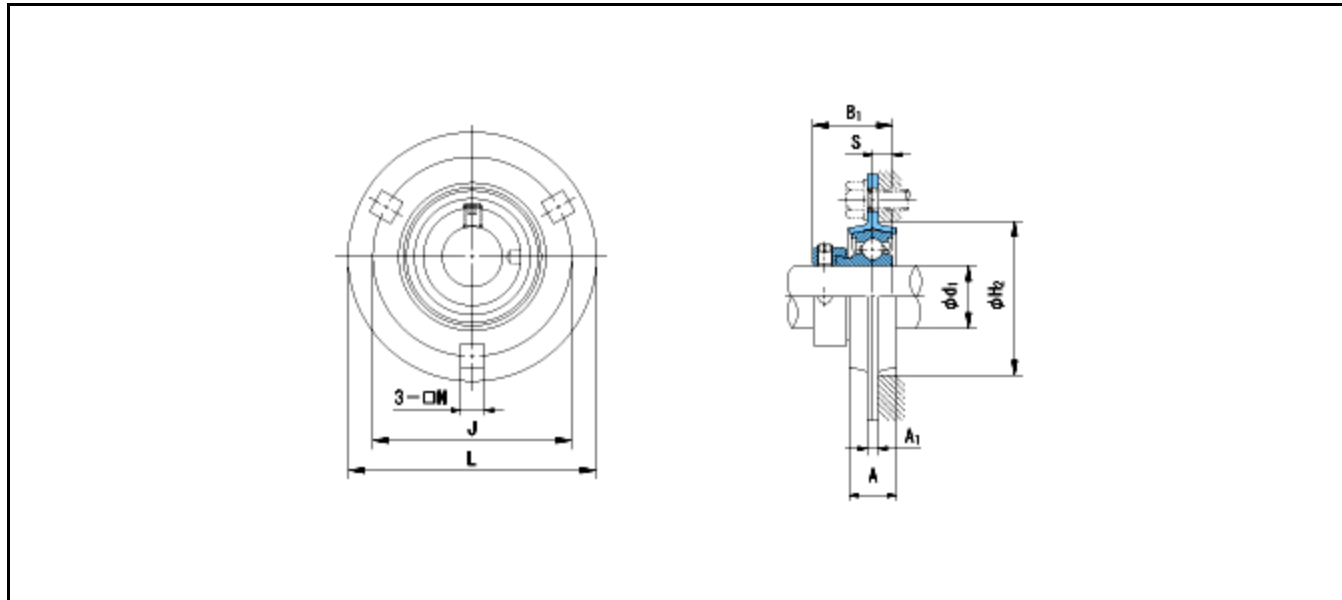

Dimensions

d1 = 17

A = 14

A1 = 4

H2 = 49

B1 = 28.6

S = 6.5

Mass = 0.21 kg

Basic Dynamic Load Rating Cr :	9550 N			
Basic Static Load Rating Cor :	4800 N			
Limiting Speed ;				
Grease Lubrication :	- rpm			
Oil Lubrication :	- rpm			
			INNER RING	OUTER RING
			O.D.Surface Runout with Side :	-
			Axial Runout with Bore :	-
			Axial Runout with Raceway :	-
			Width Variation :	-
			Radial Runout :	-