

ROECO

Bearing Data

Ball Bearing Units

Bearing No.: **KHFCC 210**

Dimensions

L = 165
J = 135
J₁ = 95.5
N = 14

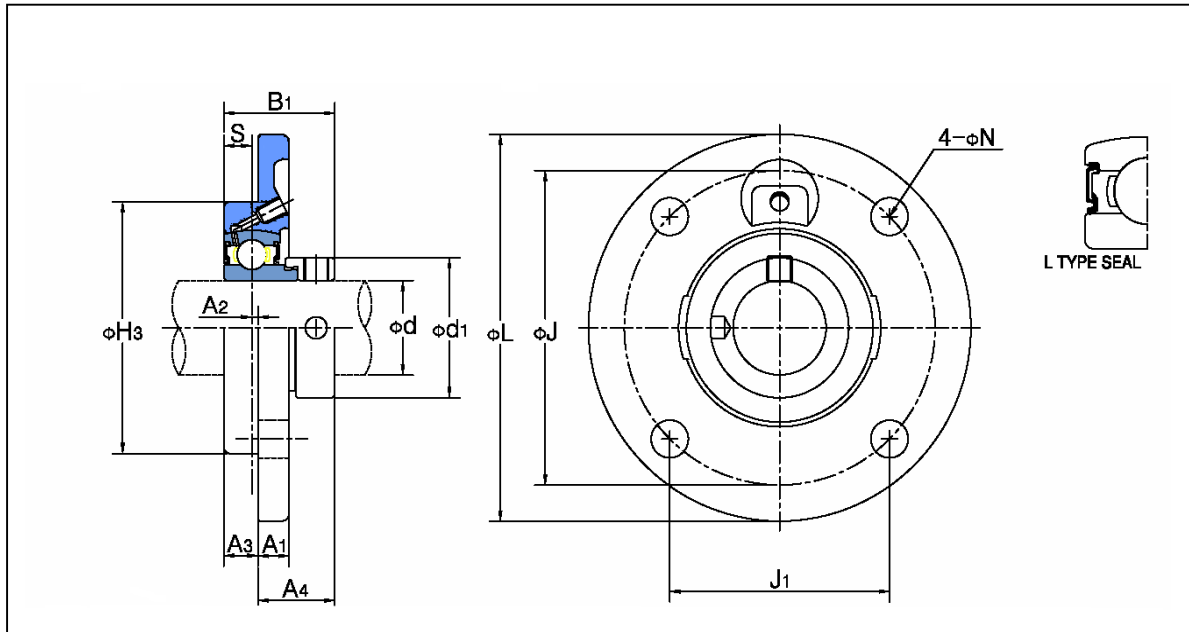

Dimensions

d = 50
H₃ = 110
A₁ = 13
A₂ = 1
A₃ = 12
A₄ = 46.4
B₁ = 58.4
S = 11
d₁ = 69.9
Bolt (mm) = 12
Bolt (inch) = 7/16
Mass (kgf) = 2.19

Basic Dynamic Load Rating C_r: 34421 N

Basic Static Load Rating C_{0r}: 22751 N