

ROECO

Bearing Data

Ball Bearing Units

Bearing No.: **KHFCC 209**

Dimensions

L = 155
J = 130
J₁ = 91.9
N = 14

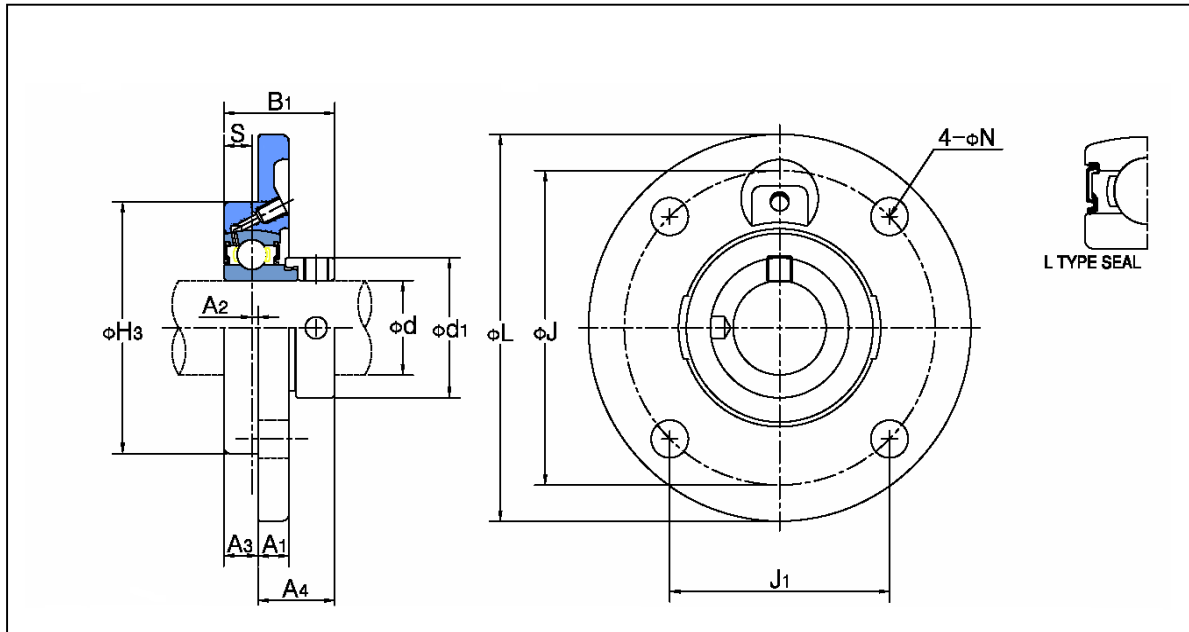

Dimensions

d = 45
H₃ = 105
A₁ = 12
A₂ = 2
A₃ = 13
A₄ = 39.8
B₁ = 52.8
S = 11
d₁ = 63.5
Bolt (mm) = 12
Bolt (inch) = 7/16
Mass (kgf) = 2.05

Basic Dynamic Load Rating C_r: 31381 N

Basic Static Load Rating C_{0r}: 20006 N