

ROECO

Bearing Data

Ball Bearing Units

Bearing No.: **KHFCC 204**

Dimensions

L = 100
J = 78
J₁ = 55.2
N = 9

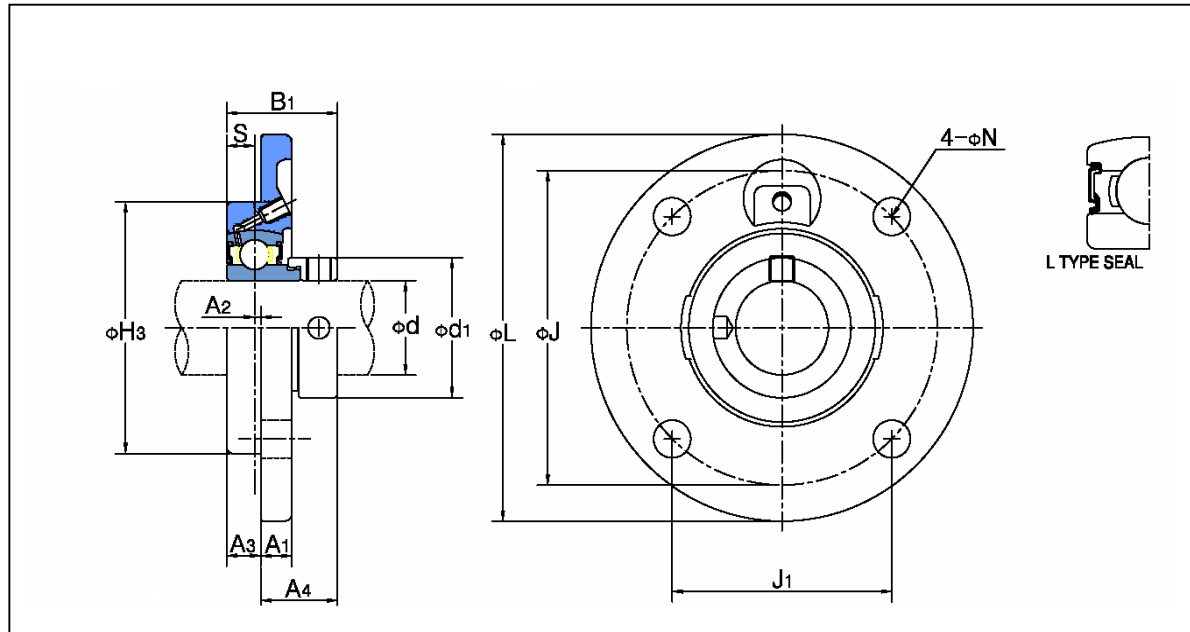

Dimensions

d = 20
H₃ = 62
A₁ = 8
A₂ = 2
A₃ = 9
A₄ = 21.5
B₁ = 31.0
S = 7.5
d₁ = 33.3
Bolt (mm) = 8
Bolt (inch) = 5/16
Mass (kgf) = 0.53

Basic Dynamic Load Rating C_r: 12553 N

Basic Static Load Rating C_{0r}: 6570 N