

ROECO

Bearing Data

Ball Bearing Units

Bearing No. : **CUCF316C**

Dimensions

L = 250

J = 196

N = 31

A = 68

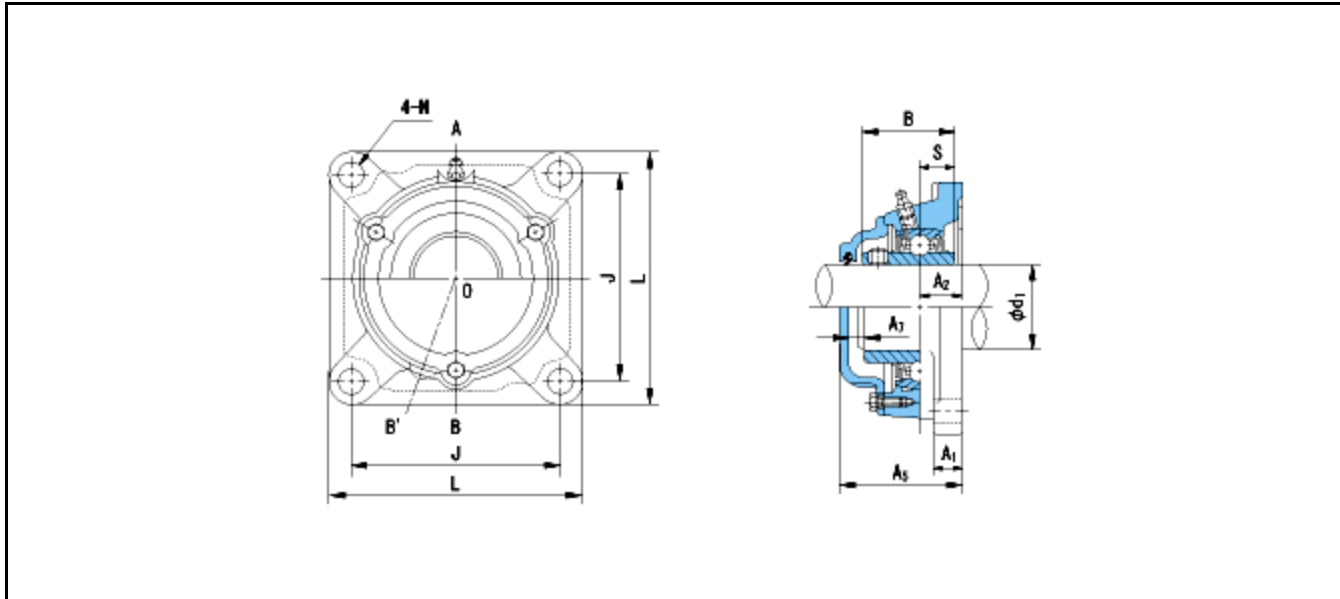

Dimensions

d1 = 80

A1 = 27

A2 = 38

B = 86

S = 34

A5 = 115

A7 = 17

Mass = 15.9 kg

Basic Dynamic Load Rating Cr : **123000 N**

Basic Static Load Rating Cor : **86400 N**

Limiting Speed ;

Grease Lubrication : - rpm

Oil Lubrication : - rpm

INNER RING OUTER RING

O.D.Surface Runout with Side : -

Axial Runout with Bore : -

Axial Runout with Raceway : -

Width Variation : -

Radial Runout : -