

ROECO

Bearing Data

Ball Bearing Units

Bearing No. : **CUCF310C**

Dimensions

L = 175

J = 132

N = 23

A = 48

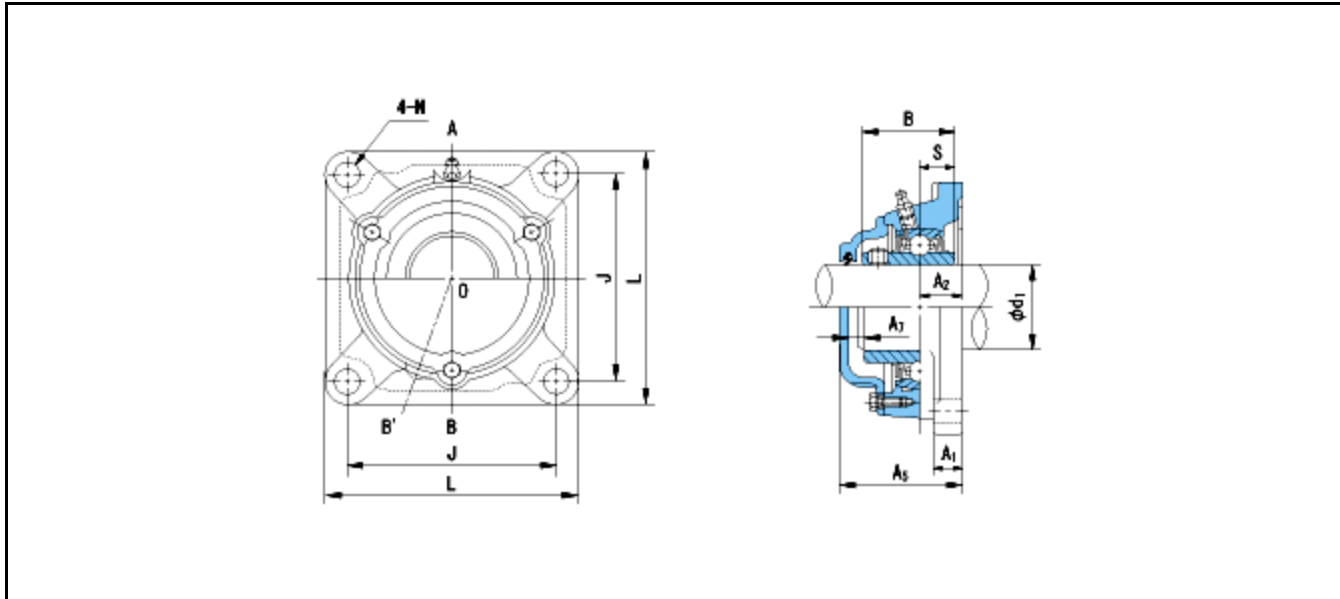

Dimensions

d1 = 50

A1 = 19

A2 = 28

B = 61

S = 22

A5 = 85

A7 = 12

Mass = 5.5 kg

Basic Dynamic Load Rating Cr :	61500 N				
Basic Static Load Rating Cor :	38200 N	O.D.Surface Runout with Side :			-
Limiting Speed ;		Axial Runout with Bore :			-
Grease Lubrication :	- rpm	Axial Runout with Raceway :			-
Oil Lubrication :	- rpm	Width Variation :			-
		Radial Runout :			-