

ROECO

Bearing Data

Ball Bearing Units

Bearing No. : **CUCF214CE**

Dimensions

L = 193

J = 152

N = 19

A = 54

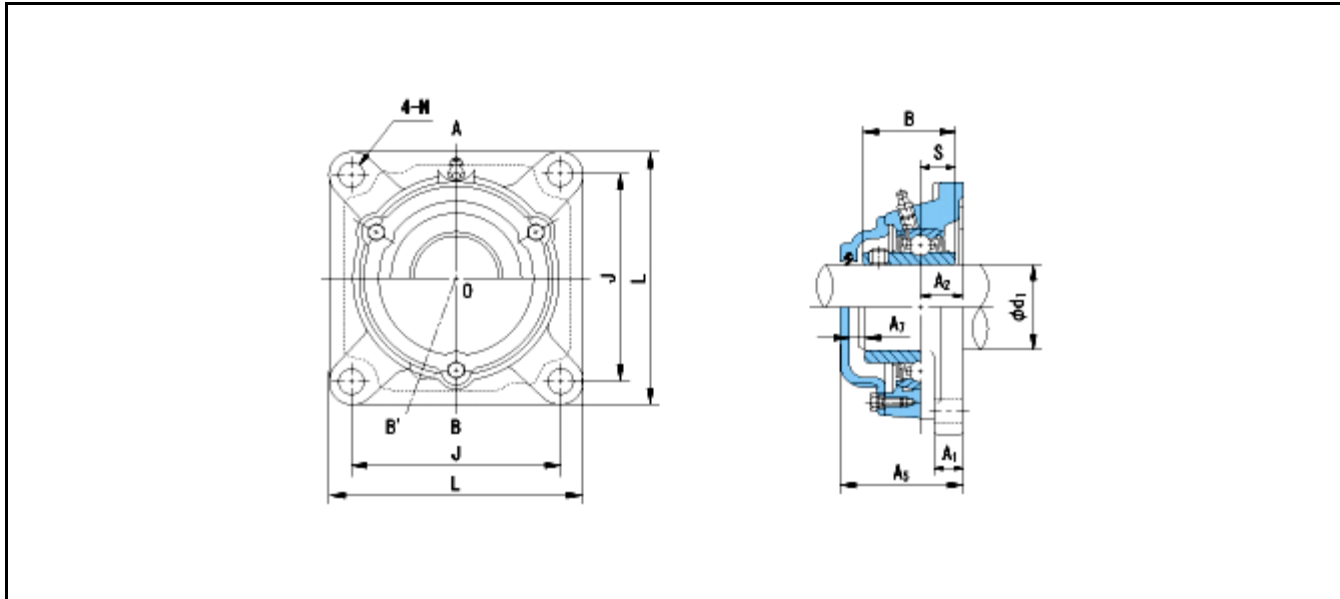

Dimensions

d1 = 70

A1 = 24

A2 = 31

B = 74.6

S = 30.2

A5 = 98

A7 = 16

Mass = 7.8 kg

Basic Dynamic Load Rating Cr :	62000 N		
Basic Static Load Rating Cor :	44000 N	O.D.Surface Runout with Side :	-
Limiting Speed ;		Axial Runout with Bore :	-
Grease Lubrication :	- rpm	Axial Runout with Raceway :	-
Oil Lubrication :	- rpm	Width Variation :	-
		Radial Runout :	-